

R2500

Compact Controller and Limiter with Program Functions

 3-349-377-03
 5/8.14

- IP 67 protection
- Sampling cycle – 100 ms 1)
- PDPI control without overshooting
- Control parameter adaptation can be started at any time
- Freely configurable outputs – 3 relay and 2 transistor
- 2-step, 3-step, continuous action and step-action controller
- Program controller – 8 programs with 12 segments each and 2 control tracks
- Split range controller (discontinuous, continuous and step-action)
- Hot-runner control with actuating circuit and booster circuit
- Water cooling control (non-linear cooling effect with evaporation)
- Temperature limiter
- Limiter for aperiodic quantities
- Data logger for actual values and setpoints
- Alarm history with time stamp
- Infrared interface at front panel with optional adapter
- Password protection
- CompactConfig software tool
- Structured operating and programming system
- RS 485 Modbus interface – , HB-Therm protocol
- Functionally compatible with R2400 electronic controller



Features

- Sensor input for thermocouples, Pt100, Ni100 or direct current, direct voltage
- Thermocouple input immune to leakage current (up to 230 V)
- Suitable for zones with temperature rises of up to 100 K/s
- Monitoring for sensor failure, reversed polarity and short-circuits
- Plausible regulated temperature becomes active in the event of sensor failure
- Setpoint ramps / staircases, proxy setpoint, setpoint limiting
- Heating circuit monitoring without additional transformer
- Heating current monitoring via external current transformer (optional)
- Numerous monitoring functions and alarms
- User-defined standard settings can be saved – 4 parameter sets – default parameters can be restored
- Exchange of parameters via binary input and interface

Description

The universal, user-friendly compact device in 1/16 DIN format (48 x 48 mm) is well suited for precision control tasks without overshooting, as well as for temperature limiting.

The integrated infrared interface in the front panel makes it possible to configure the controller with CompactConfig software either online or offline, and allows for online viewing of the control process, as well as read out and storage to memory of values from the data logger and alarm history. It can be used in machinery and equipment manufacturing, as well as in the food processing and luxury food industries, thanks to IP 67 protection at the front panel.

Filter and Functions with Distorted Controlled Variable

Designation / Parameter	Function	Limitation
Peak filter	Individual erroneous measurements caused by, for example, electrostatic discharge to the sensor, are suppressed.	---
Smoothing filter	In accordance with controlled system dynamics, several measured values are combined for control purposes to avoid an unsteady controlled variable.	---
Actual value correction, actual value factor	Linear correction of measured values, if, amongst other factors, measured temperature deviates from the temperature to be measured / to be displayed due to a temperature gradient.	---
Adaptive measured value correction	Suppression of constant periodic, or slowly changing oscillation.	Not active if period is $> \frac{1}{2} T_u^*$
Oscillation disabling (oscillation period: 0.3 to 20 s)	Suppression of oscillation with a constant period, if the period is longer than $\frac{1}{2} T_u$.	---
Feed-forward control	Suppression of controlled variable swells and dips in the event of load fluctuations, e.g. caused by operation/standstill of a machine/system	Load fluctuation interval much greater than T_u^*
Response in event of sensor failure, sensor error manipulating factor	If operation must be continued with a defective sensor, the controller reads out a plausible manipulated variable in order to maintain the working level.	---

* T_u = delay time

Detailed information is included in the operating instructions.

1) 100 ms with integrated transformation for suppression of 50/60 Hz including harmonics up to the 13th harmonic

R2500

Compact Controller and Limiter with Program Functions

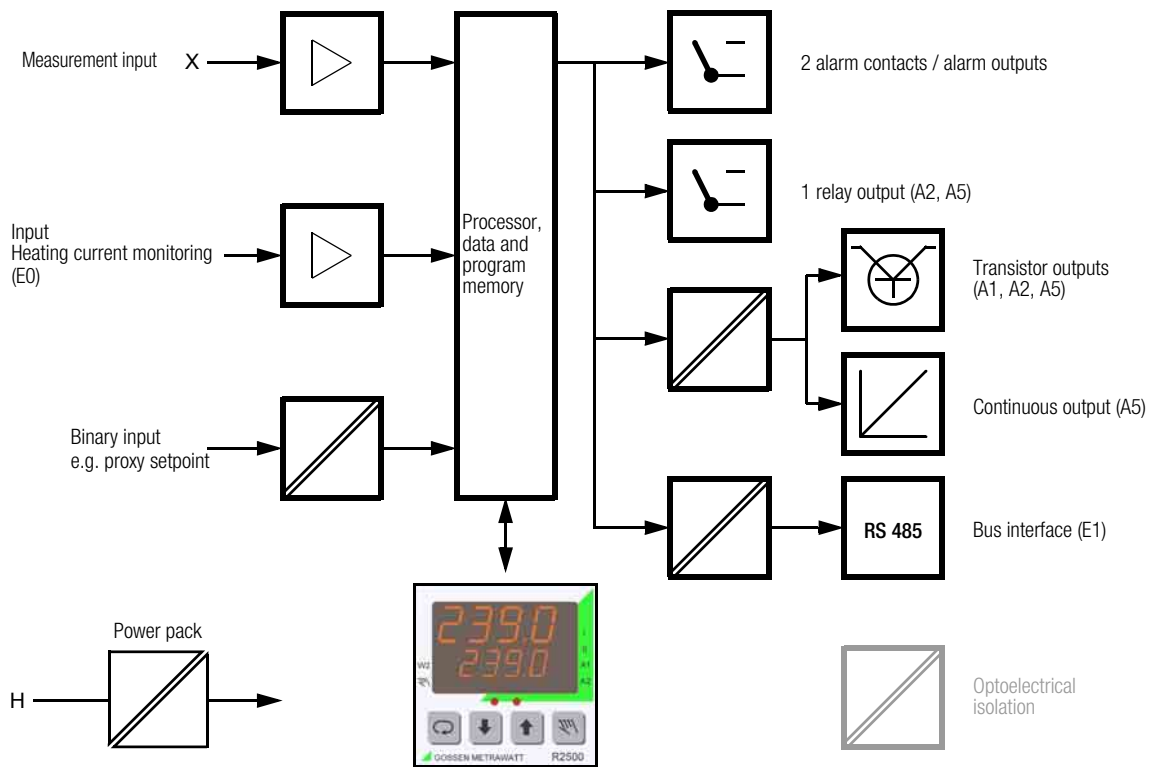

Figure 1: Schematic Diagram

Applicable Regulations and Standards

IEC 61010-1 / DIN EN 61010-1/ VDE 0411 T1	Safety requirements for electrical equipment for measurement, control and laboratory use
DIN EN 61 326 VDE 0843, part 20	Electrical equipment for control technology and laboratory use – EMC requirements
DIN VDE 0106 T1	Protection against electric shock
EN 60529	Degrees of protection provided by enclosures (IP code)

Technical Data

Inputs

Measurement input	Transformer resolution: < 0.02% MR
Measuring range	See order information
Sampling cycle	100 ms with integrated transformation for suppression of 50/60 Hz including harmonics up to the 13 th harmonic
Offset compensation	Possible by means of parameter entry

Sensor Input Configuration

Designation	Sensor Type	Selectable via Keypad
B1	Thermocouples Pt100, Ni100	See order information for measuring ranges, can be configured as °C / °F and 0.1 ° / 1 °
B2	Direct voltage, direct current	0 / 4 to 20 mA, 0 / 2 to 10 V, scalable display range

Thermocouple Types J, L, K, N, R, S, B, C, E, T and U

Continuous overload	AC sinusoidal, 50 Hz / 3 V, 1 V DC
Input impedance	> 50 kΩ
Remote	Integrated equalizing circuit
Error message	For broken sensor, polarity reversal, short-circuit (heating circuit monitoring) and temperature above or below measuring range

Resistance thermometers Pt100, Ni100

	2-Wire Connection:	3-Wire Connection
Cable resistance (both directions)	Adjustable from 0 to 30 Ω (by means of keystroke with short-circuited sensor)	0 to 30 Ω, compensated
Continuous overload	3 V / 50 Hz AC, sinusoidal 1 V DC	
Measuring Current	Approx. 0.2 mA	
Error message	For broken sensor or short-circuit, or temperature outside of measuring range	

Direct Voltage, Direct Current

	Direct Voltage	Direct Current
Measuring range	0 / 2 to 10 V, configurable	0 / 4 to 20 mA, configurable
Continuous overload	100 V	60 mA DC
Input impedance / load	> 150 kΩ	< 50 Ω
Error message	For input quantities above or below the measuring range	For input quantities above or below the measuring range

Compact Controller and Limiter with Program Functions

Heating Current Monitoring Input (with designation E0)

Meas. range, GTZ 4121 000 R... current trans. input	0 to 42.7 A AC
Measuring range, heating current monitoring input	0 to 10 V DC

Binary Input

Activation of various functions via a floating contact, or a potential-free electronic switch (optocoupler etc.), default setting: activation of the proxy setpoint.

Open circuit voltage: approx. 15 V

Short-circuit current: approx. 1 mA

Binary Input		
Activated	Voltage drop via contact	< 2 V
Inactive	Residual current via contact	< 0.02 mA

Display

	Controlled Variable	Command Variable, Heating Current or Manipulated Variable
Display Range	4-place digital	4-place digital
Display height	10 mm	7.5 mm

Status and Switching Outputs

	Symbol	Display Type
Status	W2, manual	LED
Switching outputs	I, II, A1, A2	LED

Controlled Variable

Designation	Measuring Range	Display Resolution
B1	Thermocouples, Pt100, Ni100	0.1 / 1 °C / F
B2	0 / 2 to 10 V 0 / 4 to 20 mA Scalable: -1999 to +9999 digits	1 digit

Heating Current

Measuring Range	Display Resolution
Scalable from 0 to 100.0 A	0.1 A

Control Performance

Setpoints

Setpoint limiting	Adjustable upper and lower setting limits
Proxy setpoint	Activated via binary input or bus, adjustable value
Setpoint increase (boost)	Activated via binary input or bus, value and maximum duration can be configured
Ramp Function (separate for rise and fall)	Specification of a gradual temperature change in degrees per minute, activated by means of: <ul style="list-style-type: none"> – Turn on auxiliary voltage – Change current setpoint value – Activate proxy setpoint – Switch from manual to automatic operation

Configurable Control Modes

PDPI 2-step controller	For heating or cooling, or cooling with water with non-linear cooling effect due to evaporation
PDPI 2-step controller	For heating hot-runner tools
PDPI 3-step controller	For heating and cooling
PDPI 3-step controller	For heating and cooling with water with non-linear cooling effect due to evaporation
Continuous-action controller	For heating or cooling
Continuous-action controller with split range	For continuous heating and discontinuous cooling, or for continuous cooling and discontinuous heating
Step-action controller	For heating or cooling
Limiter	Deactivation of PDPI control after limit value violation
Limit transducer	Two / three-step controller without time response

Control Parameter Setting Ranges

Display	Meaning	Setting Range
<i>Pb I</i>	Proportional band switching output I	0.1° ... MRS
<i>Pb II</i>	Proportional band switching output II (with 3-step controller)	0.1° ... MRS
<i>dbnd</i>	Dead band (for 3-step and step-action controllers)	0.0° ... MRS
<i>tu</i>	Path delay time	0.0 ... 900.0 s
<i>tc</i>	Read-out cycle time	0.1 ... 300.0 s

1) MRS = measuring range span

Self-Tuning

Can be started any time from any operating state by pressing a key, or via the interface.

Control parameters can be changed.

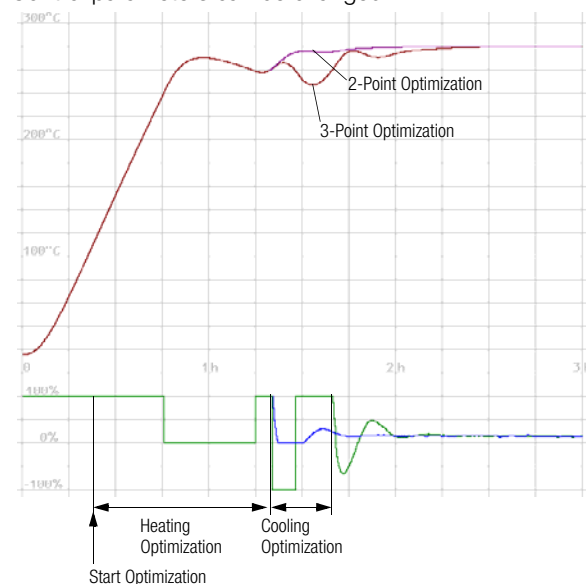

Figure 2: Control Performance with Self-Optimization

R2500

Compact Controller and Limiter with Program Functions

Hot Runner Control Functions

Actuating Circuit

Actuation with a reduced manipulating factor and dwelling at a specific actuation setpoint serves to dry out hygroscopic heating elements.

Boosting – Temporarily Increased Setpoint

Temporarily increasing the setpoint frees (up to 600 s) clogged mould nozzles of “frozen” material remnants.

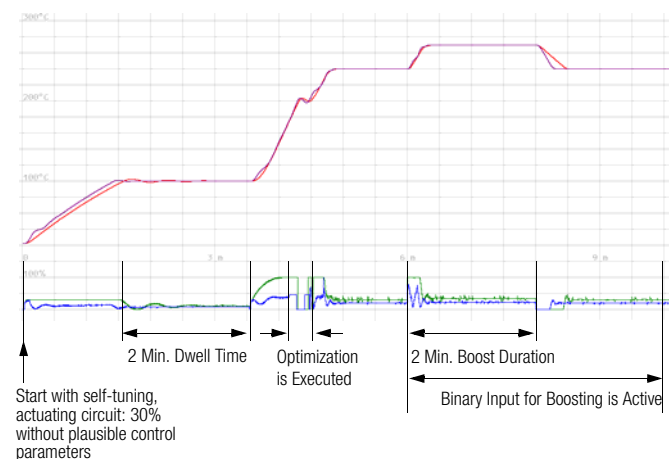

Outputs

Control Outputs

Function	Switching output I (heating) Switching output II (cooling)
Read-out cycle	Adjustable within a range of 0.1 to 300 s
Output type	Relay or transistor output
Relay output	Floating normally open contact
Switching capacity	250 V AC / DC, 2 A, 500 VA / 50 W
Service life	> 5 x 10 ⁵ switching cycles at nominal load
Interference suppression	Utilize external RC element (100 Ω - 47 nF) at contactor
Transistor output	Suitable for commercially available semiconductor relays (SSR)

Switching Status	Open-Circuit Voltage	Output Current
Active (load ≤ 800 Ω)	< DC 17 V	10 ... 15 mA
Inactive	< DC 17 V	< 0.1 mA

Overload limit Short-circuit, continuous interruption

Continuous Outputs

Output function	Actuator output for proportional actuator
Output quantity	0 (2) ... 10 V at > 1 kΩ load, 0 (4) ... 20 mA at < 300 Ω load
Signal flow direction	rising/falling
Resolution	0.1% of upper range value
Accuracy	< 3% of upper range value

Alarm Contacts / Alarm Outputs

Functions	Alternatively configurable: min, max, min + max, relative / absolute, NO / NC contact, actuation suppression off / on
Relays	Floating normally open contact, common phase for switching outputs A1 and A2
Switching capacity	250 V AC / DC, 2 A, 500 VA / 50 W
Service life	> 5 x 10 ⁵ switching cycles at nominal load
Interference suppression	Utilize external RC element (100 Ω - 47 nF) at contactor
or	
Transistor	Suitable for commercially available semiconductor relays (SSR)

Alarms

- Broken sensor, reversed polarity
- Two upper and two lower limit values, relative and absolute
- Heating current / heating circuit errors
- Adaptation errors
- Hardware errors
- Overloading of the measurement inputs
- Reference junction errors
- Parameter error

Alarm History

The alarm history includes 100 error status entries with the respective time stamps in a circulating buffer. Recording is restarted each time the device is reset.

Limit Value Monitoring

Two upper and two lower limit values can be configured. Alarm memory and actuation suppression are adjustable.

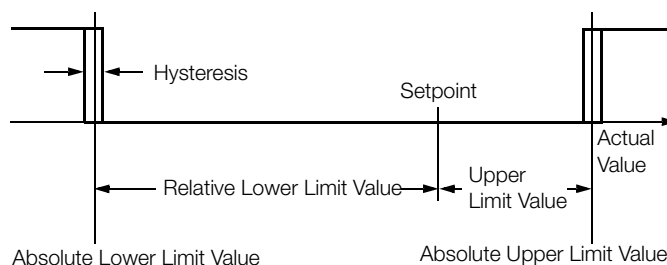

Figure 3: Schematic Representation of Relative Limit Value Monitoring

Heating Circuit Monitoring

Without external transformer, without additional parameters	
Configurable	Heating circuit monitoring active / inactive
Error Messages for	100% heat without rising temperature, i.e. in case of: short-circuited thermocouple, interrupted heating, no sensor in heating circuit

Compact Controller and Limiter with Program Functions

Heating Current Monitoring (designation E0)

Heating current acquisition

Via external current transformer GTZ4121000R....^{*)} (via other external current transformer, scaling required)

^{*)} See data sheet Z4121 regarding mech. installation and electrical connection.

Heating current nominal value transfer by means of keystroke

Error Messages for	
– Antivalence	Actuator signal OFF + heating current ON Actuator signal ON + heating current OFF
– Below current setpoint	Below heating current setpoint by more than 20% with actuator signal ON
Indication	Error message permanently wired to A1

Data Logger

The data logger has enough capacity for 3600 sampled value pairs including actual values and manipulated variables in a circulating buffer.

Recording duration can be set within a range of 6 minutes to 12 days.

Recording is restarted each time the device is reset.

Accuracy

Controlled Variable Input	Error Limit ²⁾ Relative to MRS ¹⁾	Resolution
Thermocouple		
– type J, L, K, N, E	< 0.7 %	0.1 K
– type U, C	< 1.4 %	0.1 K
– type B > 600 °C, type R, S, T	< 2.0 %	0.1 K
Resistance thermometers		
– Pt100	< 0.7 %	0.1 K
– Ni100	< 1.4 %	0.1 K
Direct voltage, direct current	< 0.5%	0.01 % MRS ¹⁾ + 1 Digit
	Error limit	
Remote	± 2 K	
	Error limit relative to measured value	Offset error
Heating current input	5%	± 0.1%
	Error limit relative to upper range value	Resolution
Continuous output	< 1.5%	< 0.1%

¹⁾ MRS = measuring range span

²⁾ Error limit relative to MRS < 0.1% upon request

Reference Conditions

Reference Quantity	Reference Condition
Ambient temperature Tref	23 °C ± 2 K
Reference junction temperature Tver	23 °C ± 2 K
Auxiliary voltage	Nominal value ± 1%, at AC 50 Hz ± 1% sinusoidal, allowable common-mode voltage to electrically connected inputs: 0 V DC / AC
Warm-up time	5 minutes (inputs within measuring range)

Influencing Quantities and Influence Error

Influencing Quantity	Nominal Range of Use	Maximum Influence Error
Ambient temperature	0 °C ... + 50 °C	± 0.05% MRS ¹⁾ / K
Reference junction temperature Tver	0 °C ... + 50 °C	0.1 K (Tver – Tref) / K
Cable resistance		
– Thermocouple	RL = 0 ... 200 Ω	0.1% MRS ¹⁾ / 10 Ω
– Pt100, 2-wire	RL = 0 ... 30 Ω	3 K / Ω (adjustable)
– Pt100, 3-wire	RL = 0 ... 30 Ω	0.2% MRS ¹⁾ / 10 Ω
Warm-up influence	≤ 5 min.	± 1%

¹⁾ MRS = measuring range span

Electromagnetic Compatibility

Interference emission	EN 61326 measuring method: EN 55011, class B limit value		
interference immunity	EN 61326		
Test type	Standard	Test severity	Criterion
ESD	EN 61000-4-2	4 kV contact discharge	B
		8 kV atmospheric discharge	B
E field	EN 61000-4-3	10 V / m 80 ... 1000 MHz	A
Burst	EN 61000-4-4	4 kV at all connector cables	A
Surge voltage	EN 61000-4-5	0.5 kV asymmetrical DC system	B
		2 kV asymmetrical AC system	B
		1 kV symmetrical AC system	B
		2 kV asymmetrical, all other lines	B
HF	EN 61000-4-6	10 V 0.15 ... 80 MHz, all terminals	A
Voltage dip	EN 61000-4-11	½ period	A

Electrical Safety

Safety class	II, panel-mount device per DIN EN 61010-1, section 6.5.4
Fouling factor	2, per DIN EN 61010-1, section 3.7.3.1 and IEC 664
Measuring category	II, per DIN EN 61010, appendix J, and IEC 664
Operating voltage	300 V per DIN EN 61010

Ambient Conditions

Annual mean relative humidity, no condensation	75%
Ambient temperature	
– Nominal range of use	0 °C ... + 50 °C
– Operating range	0 °C ... + 50 °C
– Storage range	–25 °C ... + 70 °C

Auxiliary voltage

Nominal Value	Nominal Range of Use		Power Consumption
	Voltage	Frequency	
110 V AC 230 V AC	85 to 265 V AC	48 to 62 Hz	Typically 1.5 W
24 V DC	20 to 30 V DC	–	

R2500

Compact Controller and Limiter with Program Functions

Data Interfaces

IR Interface

Baud rate 19.2 kBaud

Accessory bidirectional IR-USB interface adapter Z250I is required.

Bus Interface (designation E1)

Type (interchangeable)	RS 485
Maximum number of devices	32
Number of strands, connection	3 screw terminals
Transmission speed	9.6 / 19.2 kBaud
Protocol	Modbus HB-THERM DIN draft 19244 (R2600, GTR0217)
Designation	E1

Mechanical Design

Type	Panel-mount device per DIN 43700, housing made of plastic per UL V0, side-by-side mounting without separator
Panel cutout	45 ^{+0.6} x 45 ^{+0.6} mm
Mounting position	Front panel vertical or tilted back up to 45°
Protection	IP 67 front IP 20 housing IP 20 terminals
Weight	Approx. 150 g

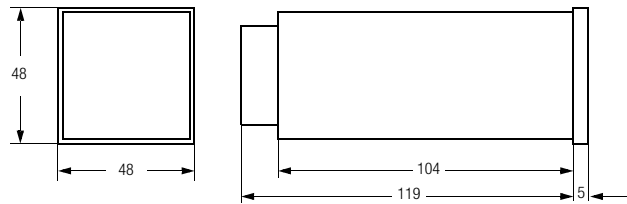

All dimensions in mm

Figure 4: Housing Dimensions

Electrical Connection

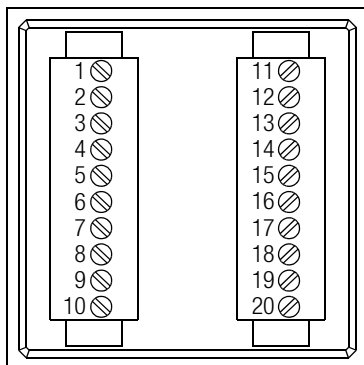
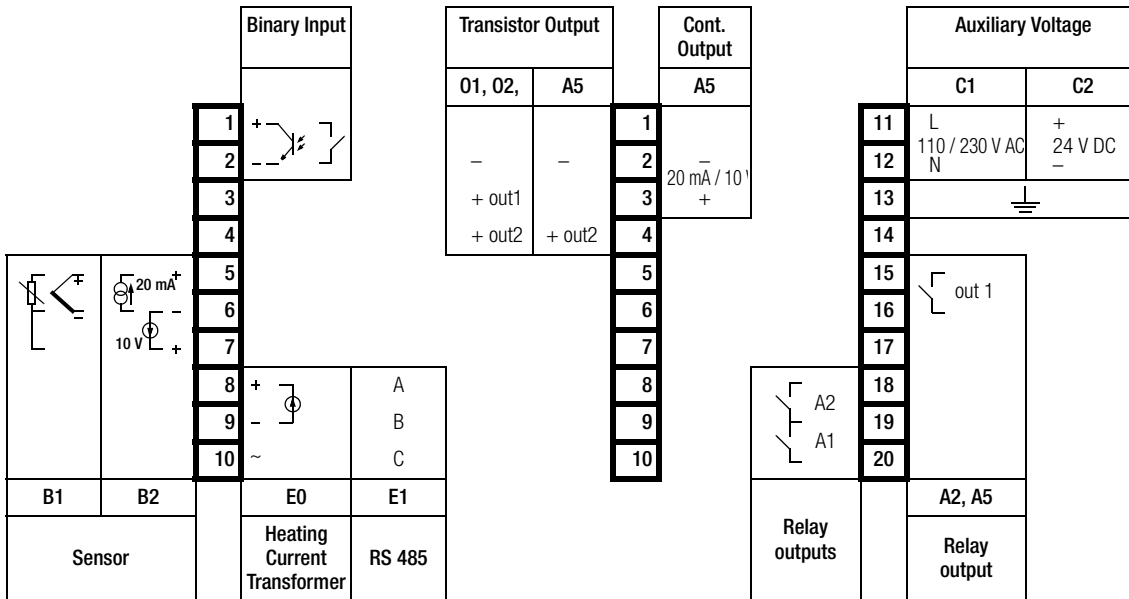

Connector components Screw terminals, suitable for wire with 1.5 square mm cross-section or two-core wire-end ferrules with a cross-section of 2 x 0.75 square mm

Figure 5: Connector Terminal Positions

R2500

Compact Controller and Limiter with Program Functions

Included

- Controller as ordered depending upon designation
- 2 mounting components
- Operating instructions, language according to designation

Order Information

The following applies for the selection of order features: Only *one* designation beginning with any given capital letter may be selected. If the capital letter is followed by zeros only, the designation need not be entered.

Characteristic	Designation
Compact controller: 48 x 48 mm, IP 67, with self-tuning, proxy setpoint and 2 alarms, hot-runner functions, data logger, alarm history, infrared interface for configuration tool and graphic tool	R2500
Controller type	Outputs
Two-step, three-step controller, step-action controller	2 transistor, 2 relay
Two-step, three-step controller, step-action controller	2 transistor, 3 relay
Continuous, split range controller, Discontinuous-action controller	1 continuous, 1 transistor, 3 relay
Measuring ranges	
Configurable measurement input	
Thermocouple	
Type J, L	0 ... 900 °C / 32 ... 1652 °F
Type K, N	0 ... 1300 °C / 32 ... 2372 °F
Type R, S	0 ... 1750 °C / 32 ... 3182 °F
Type B	0 ... 1800 °C / 32 ... 3272 °F (accuracy specified as of 600 °C)
Type C	0 ... 2300 °C / 32 ... 4172 °F
Type E	0 ... 700 °C / 32 ... 1292 °F
Type T	0 ... 400 °C / 32 ... 752 °F
Type U	0 ... 600 °C / 32 ... 1112 °F
Resistance thermometer	
Pt100	- 200 ... 600 °C / -328 ... 1112 °F
Ni100	- 50 ... 250 °C / -58 ... 482 °F
Measurement input:configurable standard signal	
0 / 2 ... 10 V or 0 / 4 ... 20 mA	B2
Auxiliary voltage	
85 V ... 265 V AC, 48 Hz ... 62 Hz	C1
20 to 30 V DC	C2
Extras	
Heating Current Monitoring	E0
RS 485 data interface	E1
Configuration	
Default settings	K0
Configured per customer requirements	K9
Operating Instructions	
German	L0
English	L1
Italian	L2
French	L3
None	L4

R2500

Compact Controller and Limiter with Program Functions

Sample order: R2500 A2 B1 C1

Feature (plain text)		Designation
Compact controller	48 x 48 mm, IP 67, with self-tuning, proxy setpoint and 2 alarms, hot-runner functions, data logger, alarm history, infrared interface for configuration tool and graphic tool	R2500
Controller types	Two-step, three-step, step-action controller with 2 transistor outputs and 3 relay outputs	A2
Measuring range	Thermocouple, Pt100, Ni100	B1
Auxiliary voltage	85 ... 265 V AC, 48 ... 62 Hz	C1
Extras	Heating current monitoring	E0
Configuration	Default settings	K0
Operating Instructions	German	L0

Standard Models

Characteristic	Designation
Compact controller, 48 x 48 mm, with 2 transistor and 2 relay outputs, temperature measurement input, auxiliary voltage: 85 to 265 V AC R2500 A1 B1 C1 E0 K0 L0	R2500-V001
Compact controller, 48 x 48 mm, with one each continuous, transistor and 3 relay outputs, temperature measurement input, auxiliary voltage: 85 V to 265 V AC R2500 A5 B1 C1 E0 K0 L0	R2500-V002

Accessories

Characteristic	Article Number
Current transformer , top-hat rail mounting, for acquiring heating current	
With 3 inputs (one 3-phase consumer or 3 single-phase AC consumers)	GTZ4121000R0001
With 4 inputs (one 3-phase consumer + one single-phase AC consumer, or four single-phase AC consumers)	GTZ4121000R0002
USB R2500	Z250I

CompactConfig software for R2500 / R2700

(German, English, French, Italian)

- Software for online and offline device and parameters configuration
- Automatic generation of a wiring diagram
- Online viewing of the control process
- Read-out and storage of values from the data logger and from alarm history
- Administration of parameter sets
- Graphic setup of the program controller

You require the IR adapter Z250I to be able to use the configuration tool.

Further information regarding accessories, as well as software which can be downloaded free of charge, is available on the Internet at:
www.gossenmetrawatt.com

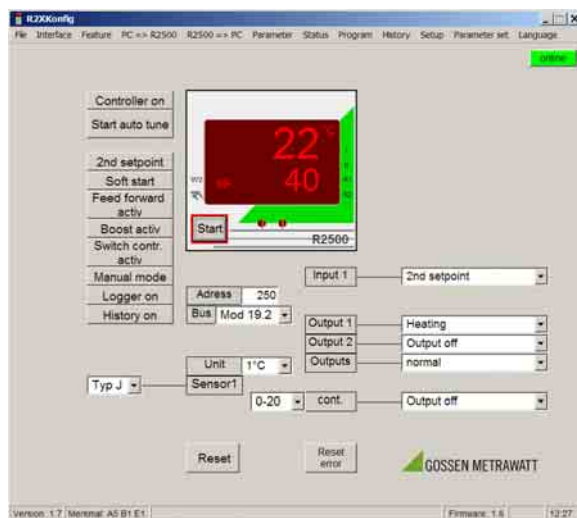

Edited in Germany • Subject to change without notice • PDF version available on the Internet



GMC-I Messtechnik GmbH
Südwestpark 15
90449 Nürnberg • Germany

Phone +49 911 8602-111
Fax +49 911 8602-777
E-Mail info@gossenmetrawatt.com
www.gossenmetrawatt.com